

---

# Setting Up the System

Publication Number 16500-90923  
First Edition, May 1993

For Safety Information, Warranties, and Regulatory information, see the pages at the back of this book

© Copyright Hewlett-Packard Company 1993  
All Rights Reserved

---

## HP 16500B Logic Analysis System

---

# Introduction

Welcome to the Hewlett-Packard 16500B Logic Analysis System. The HP 16500B system has been designed to be the easiest measurement system to use, ever. Its modular mainframe allows you to configure the system with just the measurement modules you want.

This manual explains how to prepare the logic analysis system for operation. It tells you how to inspect and prepare the system, and provides step-by-step instructions for connecting optional equipment and turning on the power to the system.

After you have read this manual and unpacked, inspected, and begun operating the instrument, your next step depends on your own needs:

- If you are a first-time user, you should read the two “Feeling Comfortable” books included with the HP 16500B.
- If you want to learn about the system interface and get hands-on training using the HP 16500B system to make real measurements, try some of the exercises in the *Logic Analyzer Training Kit*.
- If you are familiar with logic analyzers and digitizing oscilloscopes, you may want to go directly to the *HP 16500B User's Reference* and the user's references or programming guides for your measurement modules.

---

# Contents

## **1 Getting Started**

- Initial Inspection 1-2
- To Set Up the HP 16500B Mainframe 1-4
- To Connect a Mouse 1-5
- To Connect a Keyboard 1-6
- To Connect Both a Mouse and Keyboard 1-7
- To Set Up an HP 16501A Expander Frame 1-8
- To Apply Power to the System 1-10
- To Adjust the Display 1-11
- To Disconnect a Mouse, Keyboard, or Trackball 1-12

## **2 Operating the System**

- The System Configuration Menu 2-2
- Common Fields 2-3
- User Interfaces 2-4
- To Use the Touchscreen and Knob 2-5
- To Use a Mouse 2-6
- To Use a Keyboard 2-8
- What's Next? 2-10

## **3 If You Have a Problem**

- If you press the power standby switch and nothing happens 3-2
- If the instrument is on, but the display is dark 3-2
- If an "Unrecognized Card" message appears in the System Configuration menu 3-3
- To Select the Proper Line Voltage 3-4
- To Check the Fuse 3-4
- To Install the Fuse 3-4

1

1

This chapter provides you with information you need to set up your HP 16500B Logic Analysis System. It includes information on inspecting the instrument when you initially receive it, including a list of the manuals, disks, and standard accessories you should receive with the instrument.

Once you have inspected the instrument, you can use the information in this chapter to position the instrument, to connect optional interface devices, and to turn on the instrument power. This chapter also describes the steps the HP 16500B system completes during power-up.

## Initial Inspection

Before you begin to set up your logic analysis system, you should inspect it for damage. You should also check the contents of the shipping container, to ensure that you have received the proper manuals and accessories.

- Inspect the shipping container for damage.

If the shipping container or packaging material is damaged, you should keep them until the contents of the shipment have been checked. If shipping damage has occurred or if the instrument does not operate properly, refer to the *HP 16500B/16501A Service Guide*.

- Check for the correct manuals and disks.

The manuals and disks included with the HP 16500B mainframe are:

- *Feeling Comfortable with Logic Analyzers* and *Feeling Comfortable with Digitizing Oscilloscopes*.
- this manual, *Setting Up The System*.
- *Logic Analyzer Training Kit*.
- *HP 16500B/16501A User's Reference*.
- *HP 16500B/16501A Programmer's Reference*.
- *HP 16500B/16501A Service Guide*.
- a plastic pouch containing Composite Operating System Software for the HP 16500B Logic Analysis System (multiple disks).

Each measurement module includes the following manuals:

- a User's Reference.
- a Programmer's Guide.
- a Service Guide.

**Check for standard accessories**

- One power cable
- One RS-232 loop-back connector, part number 01650-63202

The standard accessories included with each module vary from module to module. To find a list of the accessories included with your modules, refer to the reference manual for each of your modules.

- If any of the standard accessories are missing, contact the nearest Hewlett-Packard sales office.**

## To Set Up the HP 16500B Mainframe

- 1 Position the instrument to allow room for airflow through the side and rear panels.

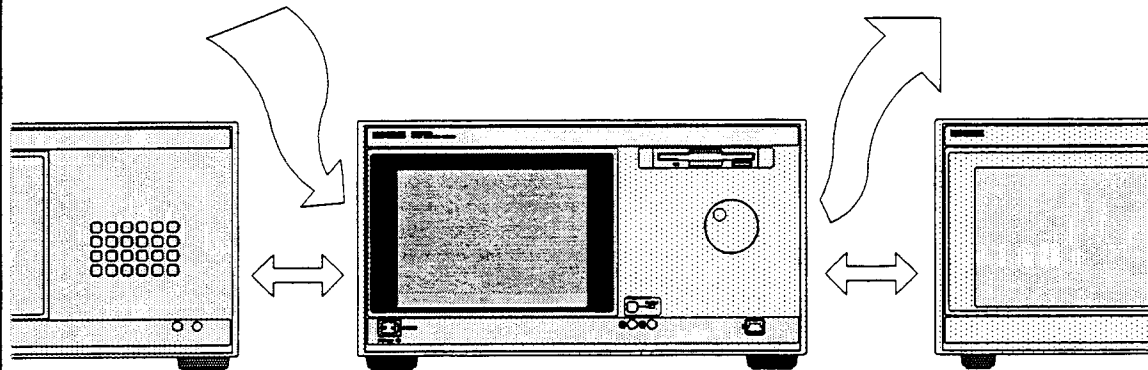

### CAUTION

Place the mainframe at least 2 inches away from any wall or away from other instruments. If there is not adequate space between the HP 16500B system and other objects, the system may overheat and may become damaged.

- 2 Set the tilt stands by pulling them forward until they lock into place. (This step is optional.)

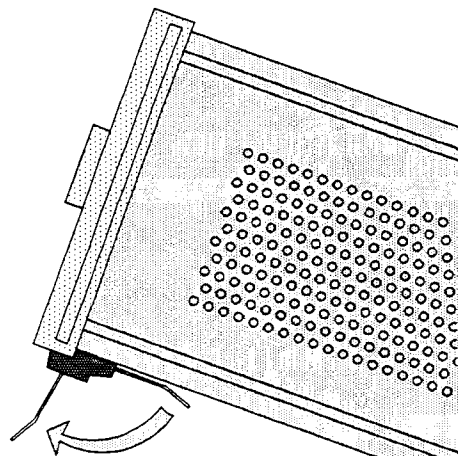



---

## To Connect a Mouse

1 If you have an optional mouse, proceed to step 2. If you do not have a mouse, go to the next page.

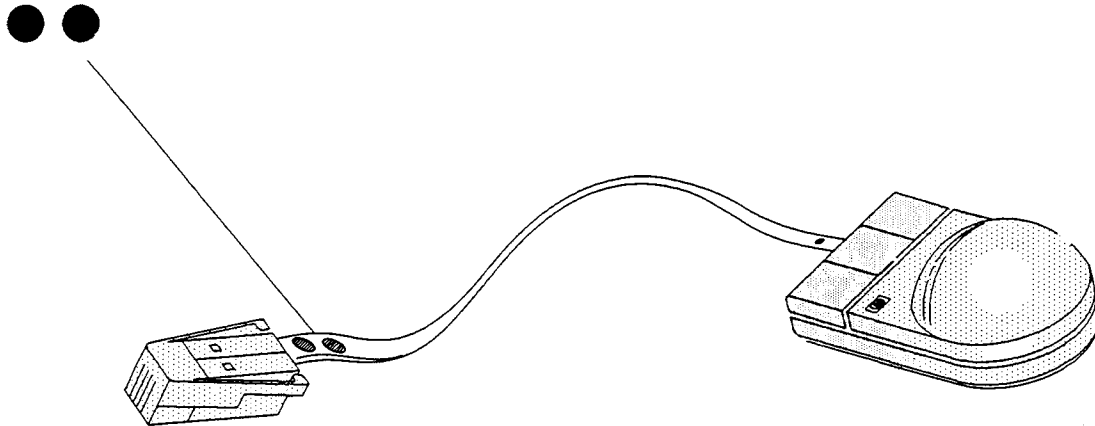

2 Plug the end of the mouse cable marked with two dots into the HIL connector on the HP 16500B front panel.

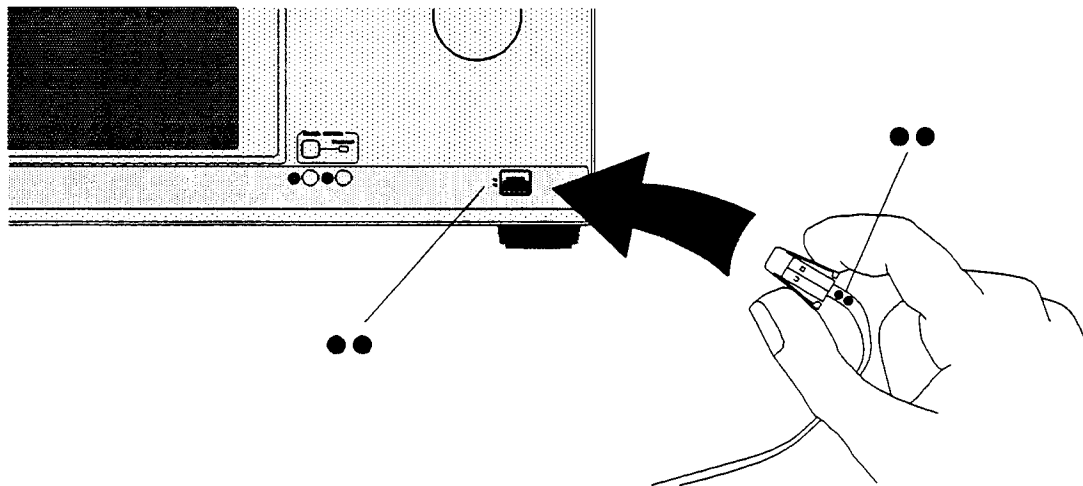

---

## To Connect a Keyboard

- 1** If you have an optional keyboard, plug the end of the cable marked with one dot into the connector marked with one dot on the back of the keyboard.

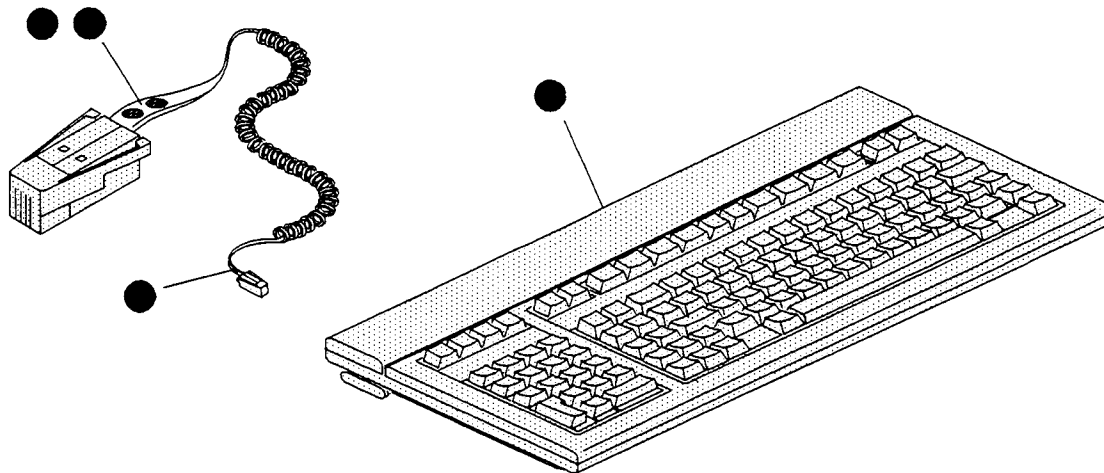

- 2** Plug the end of the keyboard cable marked with two dots into the HIL connector on the HP 16500B front panel.

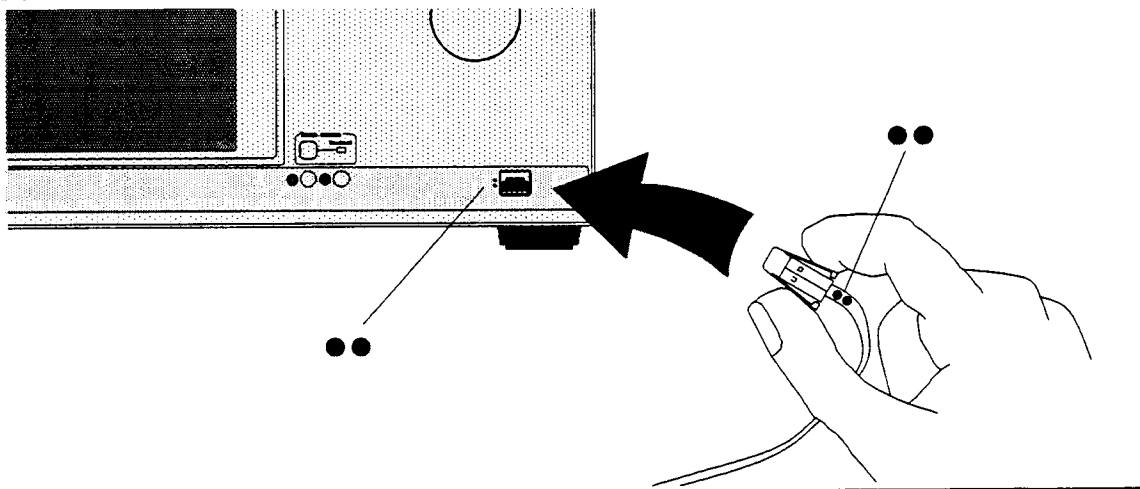

---

## To Connect Both a Mouse and Keyboard

- 1 To use a mouse and keyboard simultaneously, connect the keyboard to the HP 16500B. Plug the mouse cable into the connector marked with two dots on the back of the keyboard.

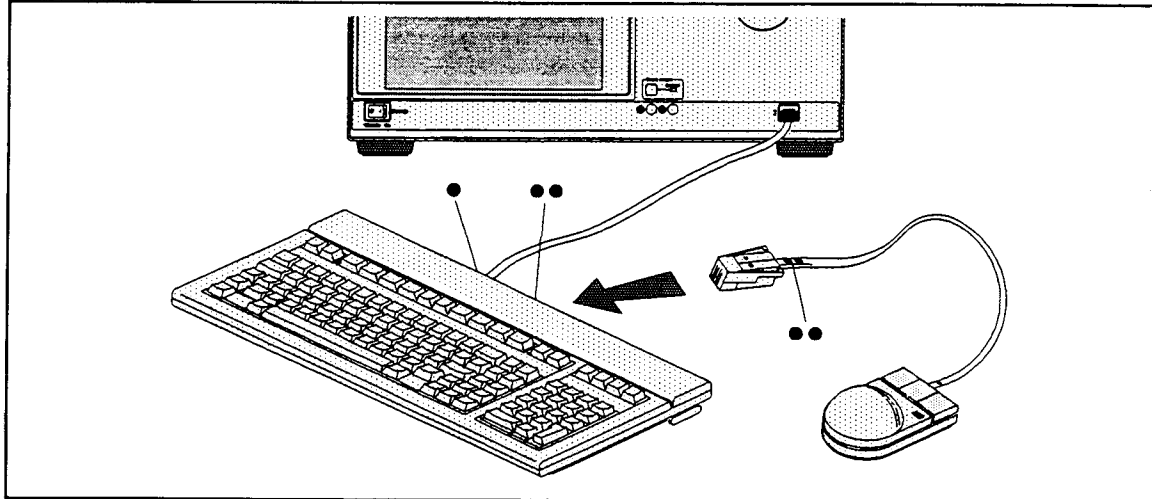

---

## To Set Up an HP 16501A Expander Frame

- 1** To insert the frame interface cable in the connectors, pinch the sides of the cable connector.

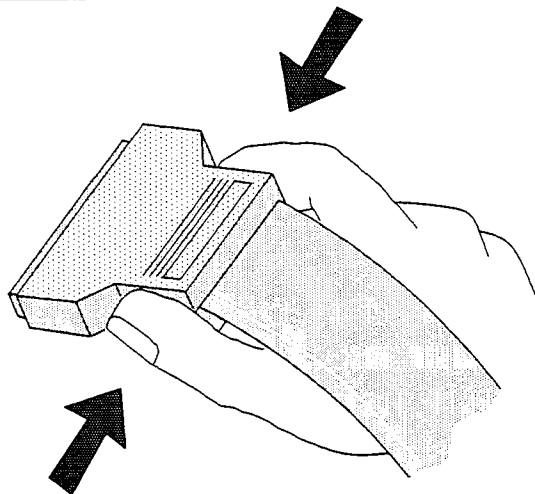

- 2** Plug one end of the frame interface cable firmly into the connector on the rear panel of the HP 16501A Expander Frame. Plug the other end into the connector on the rear panel of the HP 16500B.

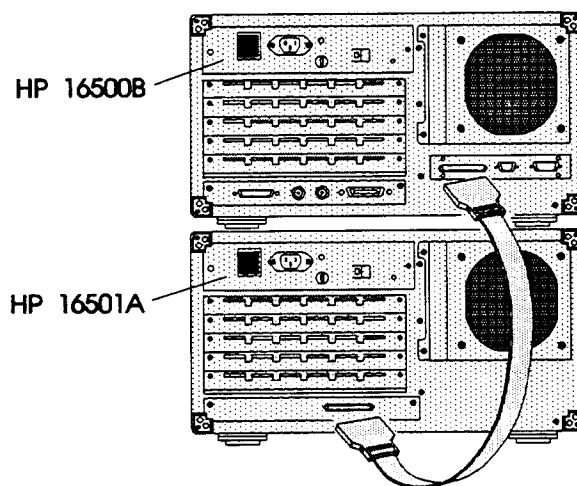

- 3** Position the expander frame to allow room for air flow through the side and rear panels of the HP 16500B and HP 16501A.

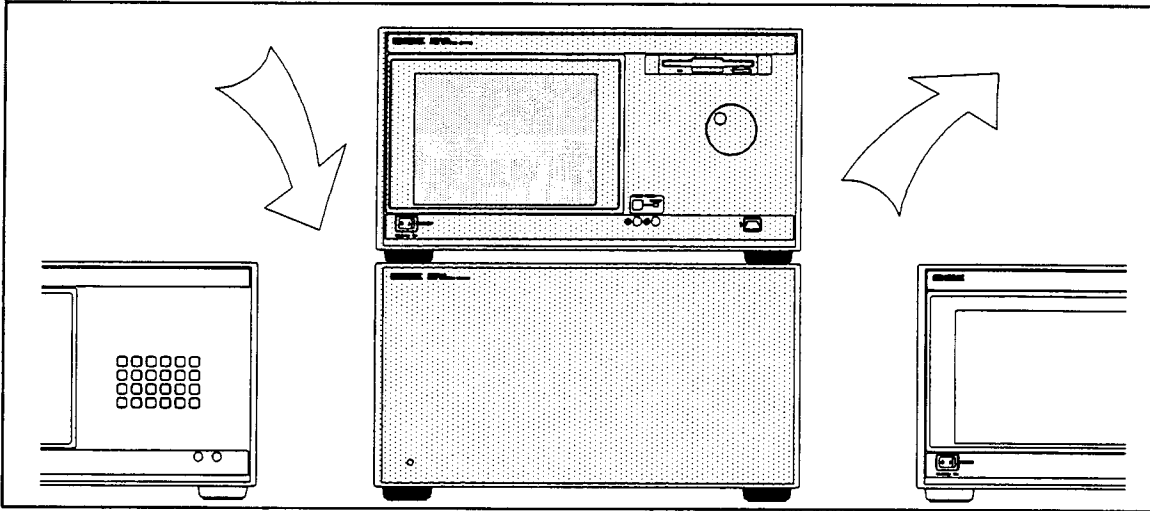

**CAUTION**

Place the mainframe and expander frame at least 2 inches away from any wall or away from other instruments. If there is not adequate space between the HP 16500 system and other objects, the system may overheat and may become damaged.

## To Apply Power to the System

- 1** Plug a power cable into the 3-prong socket on the rear panel. (Repeat for both frames if you have an HP 16501A.)

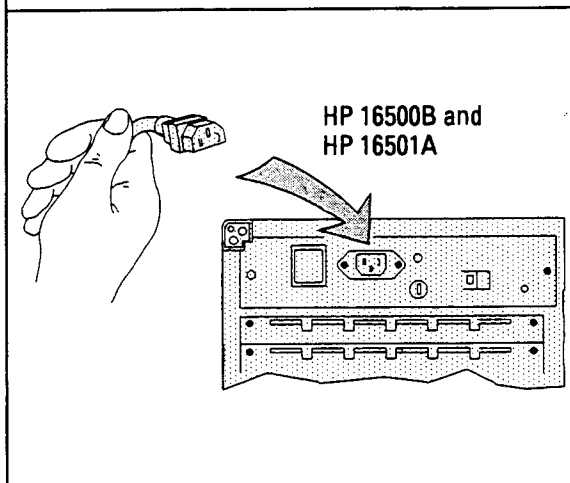

- 2** Plug the male end of the power cable into a wall receptacle.

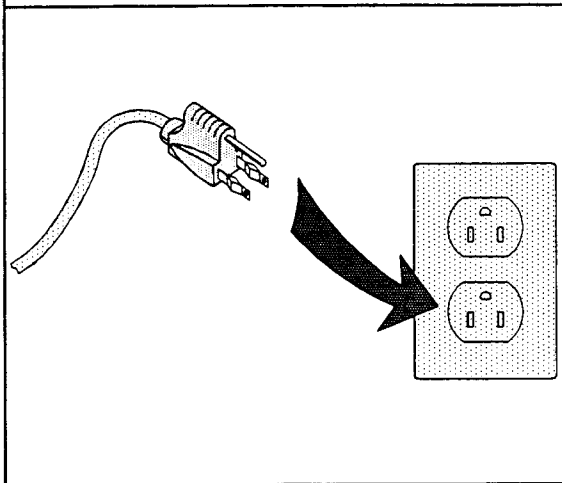

- 3** Push the top of the main power LINE switch on the rear panel. (Repeat for both frames if you have an HP 16501A.)

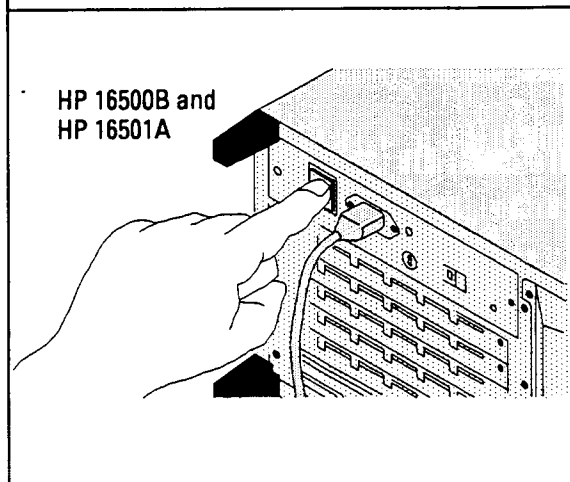

- 4** On the front panel of the HP 16500B, set the power standby switch to the ON position.

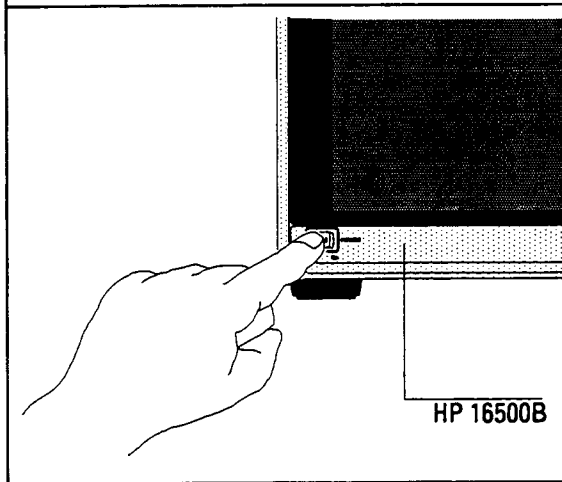

## To Adjust the Display

1 On power-up the display may appear dim.

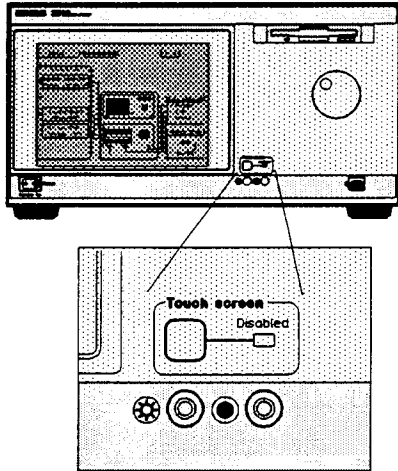

2 Turn the small knob on the left to adjust brightness.

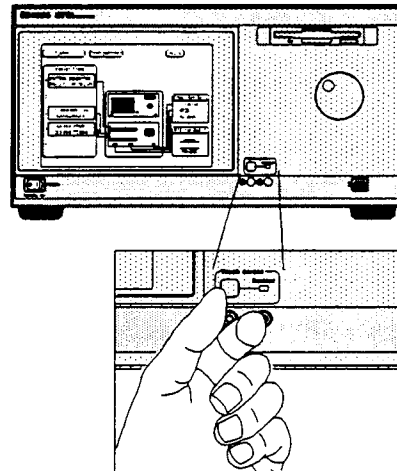

3 On power up, the display contrast may be too low.

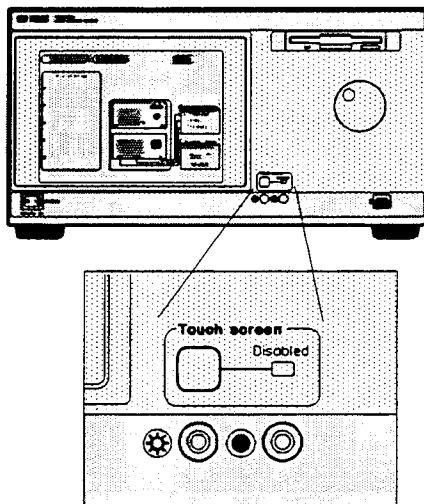

4 Turn the small knob on the right to adjust the display contrast.

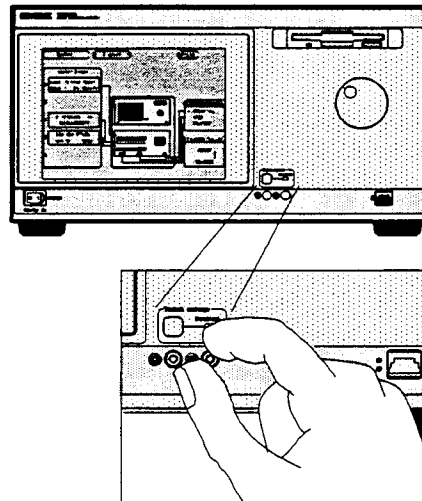

---

To Disconnect a Mouse, Keyboard, or Trackball

**1** Pinch the spring clips on the sides of the interface cable plug.

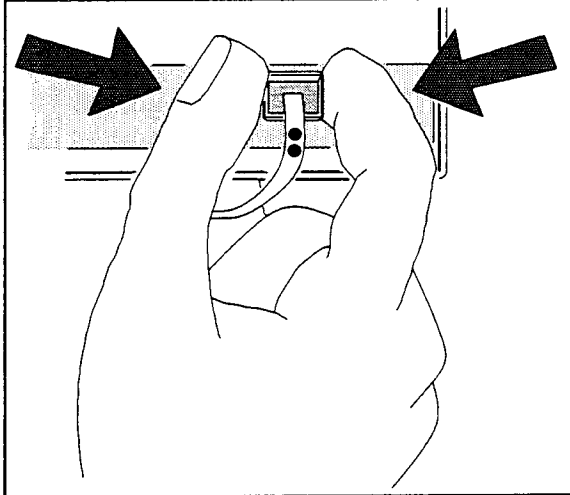

**2** Pull the plug out of the HIL connector.

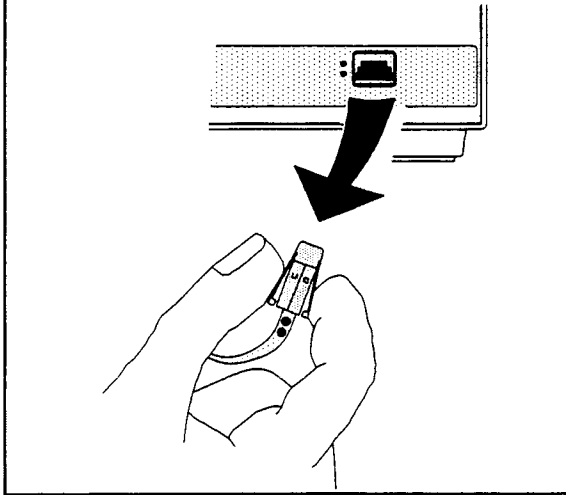



This chapter provides you with the basic information you need to start operating your HP 16500B Logic Analysis System. It describes the basic menus and fields and includes information on how to use each of the user interface devices.

---

## Operating the System

## The System Configuration Menu

When you apply power to the HP 16500B, the system takes about 30 seconds to boot up and run through self-tests. After the self-tests are completed and the operating system is loaded, the System Configuration menu will appear on screen. It is from this menu that you will start operating the instrument.

The large blue field on the left side of the display lists the modules that are installed in the HP 16500B and HP 16501A frames. In the figure below, an HP 16550A 100 MHz state/500 MHz timing module is installed in slot C of the HP 16500B mainframe. The Communications field is used to configure communications between the HP 16500B system and other devices via HP-IB, RS-232, and the optional Ethernet LAN interface. The Printer Setup field is used to configure the instrument for working with various printers.

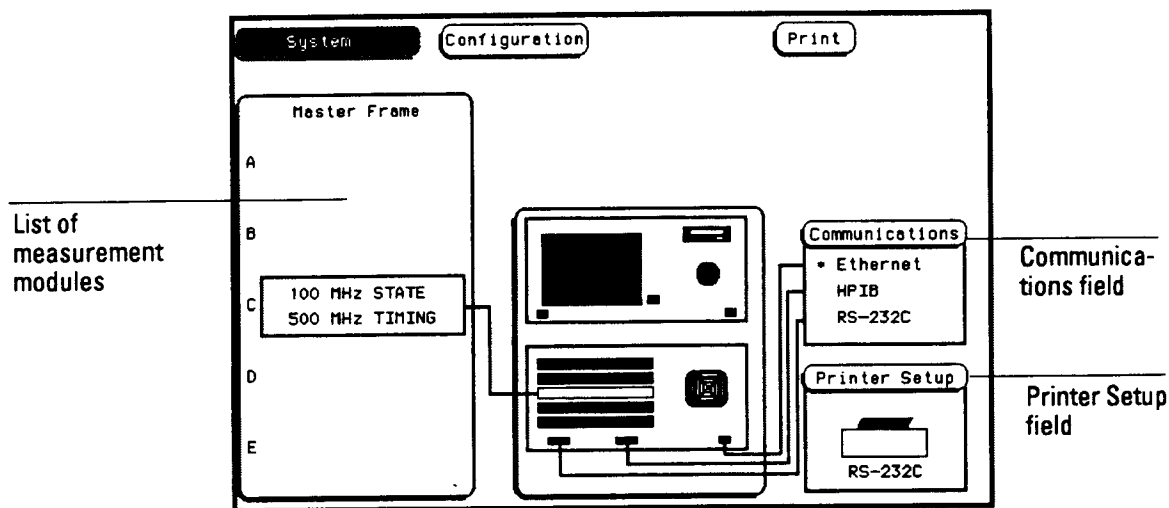

**System Configuration Menu**

## Common Fields

There are four fields on the HP 16500B screen that appear in virtually every menu. They are the Module selection, Menu selection, Run/Stop and Print fields. The locations of the fields are shown below, in the Configuration menu of the HP 16550A 100 MHz state/500 MHz timing module.

The Module field provides access to the various measurement modules that are installed in the HP 16500B or to the system-level menus, like the System Configuration menu shown on the previous page. The Menu field provides access to the control menus within a given module. For example, when the Module field is set to System, the Menu field provides access to the disk drives, Utilities menu, and Configuration menu. The Run/Stop is used to start and stop data acquisitions. The Print field is used to print information.

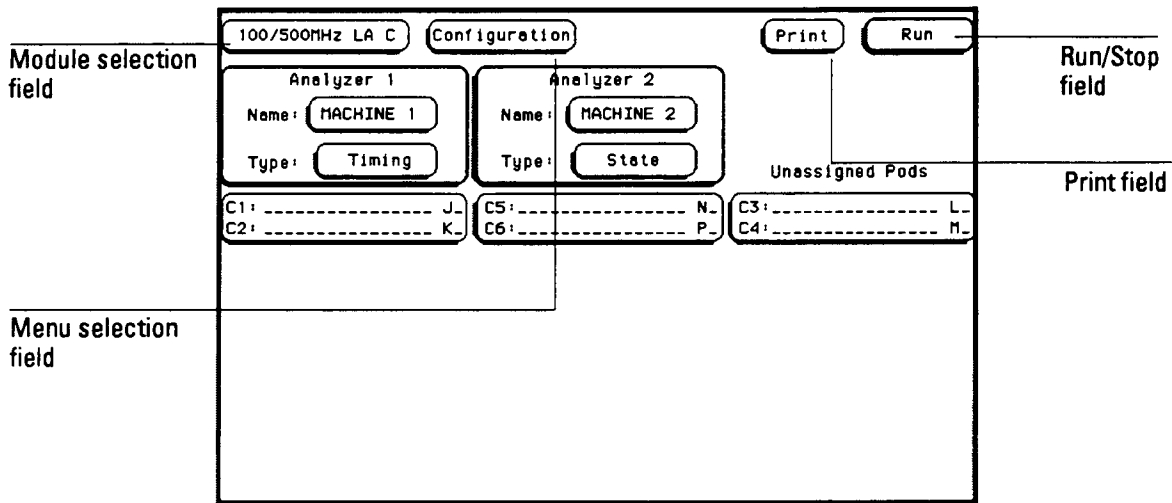

Common Fields

## User Interfaces

You can use any of four user interface devices to control the HP 16500B system: the touchscreen and knob on the front panel, the optional mouse, the optional keyboard and the optional trackball. The fields on the display - the light and dark blue boxes - can be selected and activated using any of these interfaces. The following pages show you how to use each of the interfaces.

The trackball is no longer available for purchase. If you have an HP M1309A trackball and you would like to use it to control the HP 16500 system, follow the instructions for using a mouse.

### **See Also**

"To Connect a Mouse" on page 1-5.

"To Connect a Keyboard" on page 1-6.

"To Connect Both a Mouse and Keyboard" on page 1-7.

## To Use the Touchscreen and Knob

- 1 To select an item on the display, touch it. Remove your finger from the screen to activate the item. Dark blue fields can be activated.

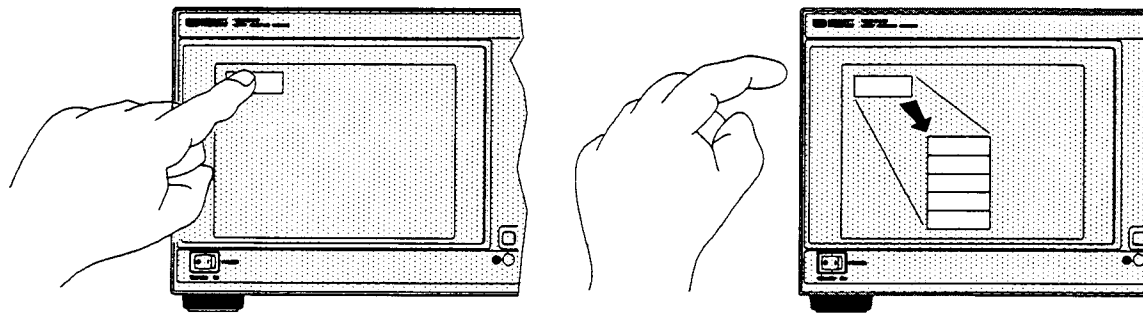

- 2 Use the knob to scroll the display or continuously update a value in a light blue field.

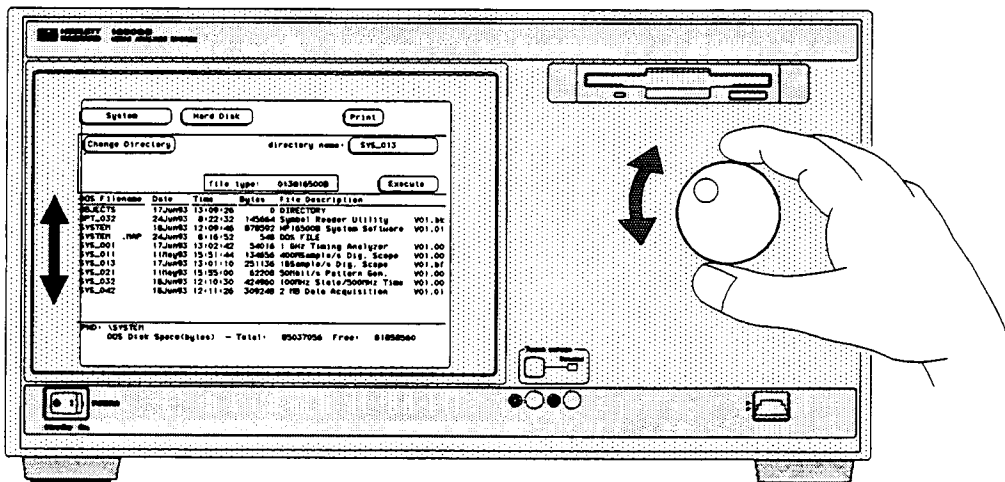

## To Use a Mouse

1 Move the mouse to move the cross-hair cursor on the HP16500B screen.

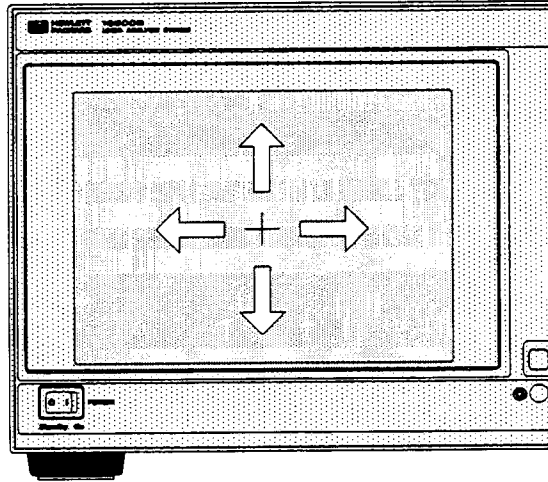
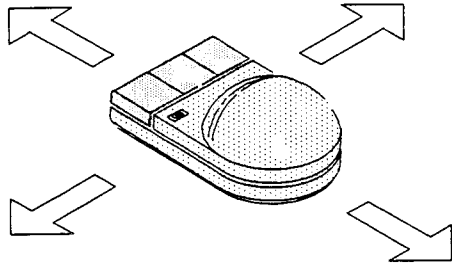

2 Press the left mouse button to select an item on the display. Dark blue fields can be selected.

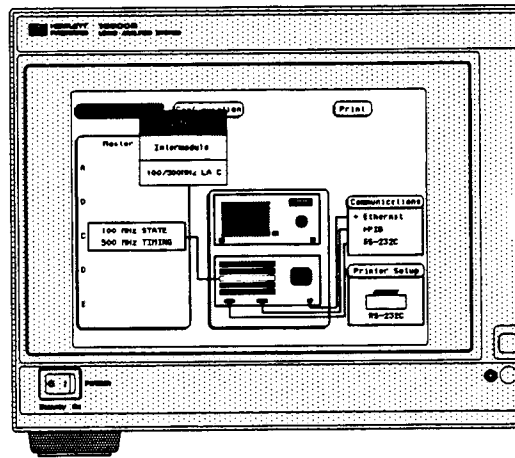
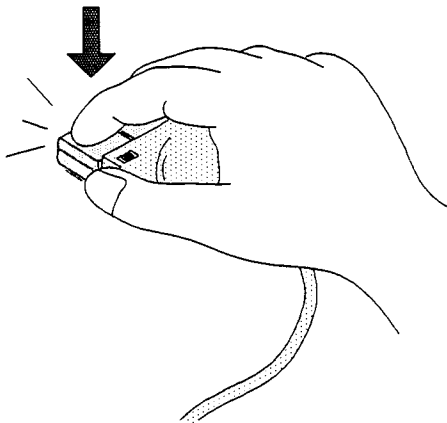



## To Use a Keyboard

1 Use the arrow keys to move the white, inverse-video cursor on the display.

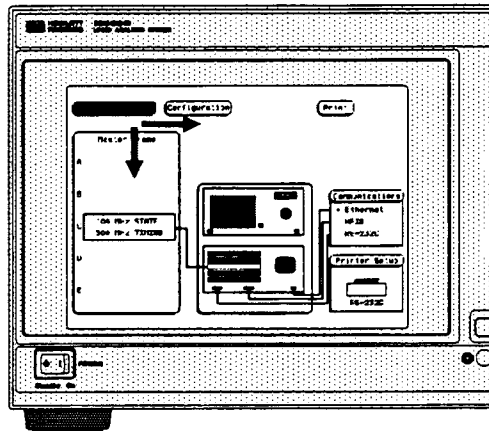
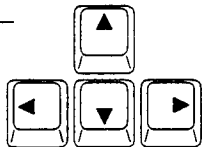
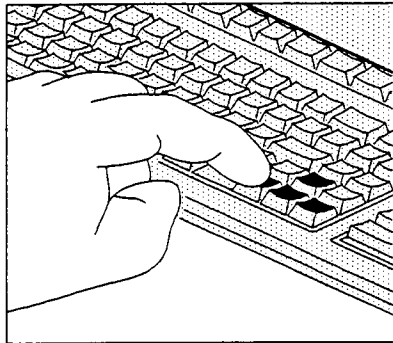

2 Press Return key to select an item on the display. Dark blue fields can be selected.

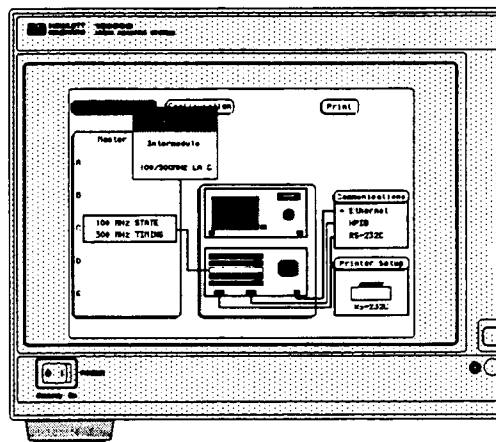
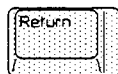
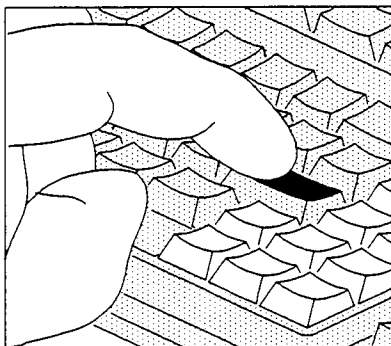



- 3 Press and hold the Shift key. Then, use the arrow keys to scroll the display or to continuously update the value of a light blue field.

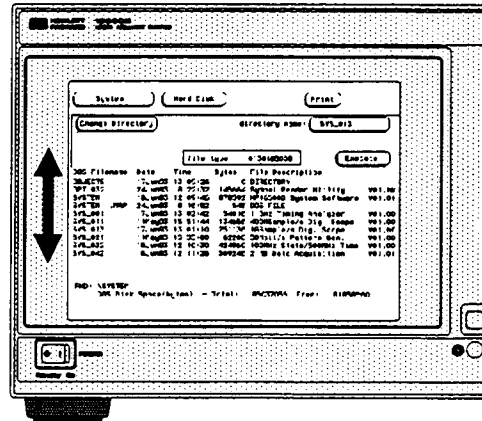
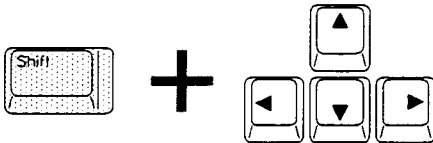
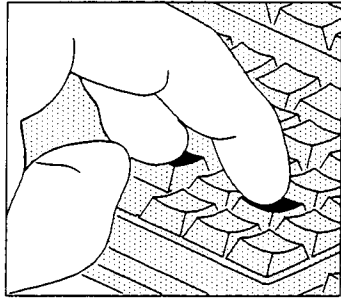

## What's Next?

Now that you have unpacked, inspected, and begun operating the instrument, your next step depends on your own needs. To begin exploring your measurement modules, activate the Module field, in the top left corner of the display. From the pop-up menu, select a module that you want to start using.

If you are a first-time user and would like more information about your logic analysis system, read the two books, *Feeling Comfortable with Logic Analyzers* and *Feeling Comfortable with Digitizing Oscilloscopes*.

If you want to learn more about the system interface and get hands-on training using the HP 16500B system to make real measurements, try some of the exercises in the *Logic Analyzer Training Kit*. The exercises in the training kit show you how to set up basic measurements through step-by-step procedures.

If you are familiar with logic analyzers and digitizing oscilloscopes, you may want to go directly to the *HP 16500B System User's Reference* and similar measurement module references. The references explain the functions and features of the HP 16500B System in a detailed, encyclopedia format.

---

If You Have a  
Problem

If You Have a Problem

**If you press the power standby switch and nothing happens**

---

### If you press the power standby switch and nothing happens

- Set the power standby switch back to the standby position.
- Make sure that the power cable is firmly plugged into the rear of the instrument and a power supply outlet.
- Make sure that the main power switch on the rearpanel is on, by pressing the top of the switch.
- Check the LINE SELECT switch, on the rear panel, to ensure that it is set to the proper input voltage level for your power supply.
- Check to see whether the fuse is intact.

**See Also**

"To Select the Proper Line Voltage" on page 3-4.

"To Check the Fuse" on page 3-4.

---

### If the instrument is on, but the display is dark

- Adjust the brightness and contrast controls on the front panel.

**See Also**

"Adjusting the Display" on page 1-11.

## If an "Unrecognized Card" message appears in the System Configuration menu

- Turn off the power.
- Securely seat the module that is not being recognized by pressing on the center of the module backing plate and by turning the thumb screws.
- Turn on the power.
- If this problem persists, verify that the hard disk contains the operating system software file for the card that is not being recognized. To check for the correct operating system:
  - 1 Select the System, Hard Disk menu.
  - 2 Select the Load field, then select Change Directory.
  - 3 Use the knob to highlight the SYSTEM subdirectory, then select Execute.
  - 4 Verify that a file called sys\_xxx is present on the hard disk. There should be a file whose File Description matches the description of the card that is not being recognized.
  - 5 If there is not a sys\_xxx file with a description that matches the card that is not being recognized, you can copy the file that you need from the flexible disks labeled "Operating System for the HP 16500 System. Copy the appropriate system file from these disks to the \system subdirectory on the hard disk.
  - 6 Turn the power off and then back on to reboot the system.

---

## To Select the Proper Line Voltage

Use the LINE SELECT switch on the rear panel of the instrument to select the appropriate voltage level for your power system. The selections are 110 Volts or 220 Volts. To change the setting:

- 1 Using a small screwdriver, push the switch to the left or right until the desired line voltage is displayed.

---

### CAUTION

Make sure that the LINE SELCT switch is set to the proper voltage for your power supply. The HP 16500B and HP 16501A can be damaged if the LINE VOLTAGE switch is no set to match the input voltage.

---

## To Check the Fuse

- 1 Push in the fuse holder gently and turn the top of the fuse holder counter-clockwise about one quarter of a turn until the top pops out.
- 2 Remove the fuse and check that it is intact.
- 3 Check the value that is marked on the fuse.

The correct value for each line voltage selection is printed on the top of the power supply (under the top cover) and in the HP 16500B/16501A Service Guide.

---

## To Install the Fuse

- 1 Put the top of the fuse holder onto the fuse and gently push the fuse into the holder on the rear panel.
- 2 Turn it clockwise until it seats itself. Then, push in gently and turn it about one quarter of a turn.

---

### WARNING

Make sure the instrument is turned off and unplugged before checking the fuse. Failure to do so could result in electric shock.

---

### WARNING

Replace fuses with the same type and rating specified in the HP 16500B/16501A Service Guide, for continued protection against fire hazard.

---

© Copyright Hewlett-Packard Company 1987, 1990, 1993

All Rights Reserved.

Reproduction, adaptation, or translation without prior written permission is prohibited, except as allowed under the copyright laws.

#### Document Warranty

The information contained in this document is subject to change without notice.

**Hewlett-Packard makes no warranty of any kind with regard to this material, including, but not limited to, the implied warranties of merchantability or fitness for a particular purpose.**

Hewlett-Packard shall not be liable for errors contained herein or for damages in connection with the furnishing, performance, or use of this material.

#### Safety

This apparatus has been designed and tested in accordance with IEC Publication 348, Safety Requirements for Measuring Apparatus, and has been supplied in a safe condition. This is a Safety Class I instrument (provided with terminal for protective earthing). Before applying power, verify that the correct safety precautions are taken (see the following warnings). In addition, note the external markings on the instrument that are described under "Safety Symbols."

#### Warning

- Before turning on the instrument, you must connect the protective earth terminal of the instrument to the protective conductor of the (mains) power cord. The mains plug shall only be inserted in a socket outlet provided with a protective earth contact. You must not negate the protective action by using an extension cord (power cable) without a protective conductor (grounding). Grounding one conductor of a two-conductor outlet is not sufficient protection.
- Only fuses with the required rated current, voltage, and specified type (normal blow, time delay, etc.) should be used. Do not use repaired fuses or short-circuited fuseholders. To do so could cause a shock or fire hazard.

- Service instructions are for trained service personnel. To avoid dangerous electric shock, do not perform any service unless qualified to do so. Do not attempt internal service or adjustment unless another person, capable of rendering first aid and resuscitation, is present.

- If you energize this instrument by an auto transformer (for voltage reduction), make sure the common terminal is connected to the earth terminal of the power source.

- Whenever it is likely that the ground protection is impaired, you must make the instrument inoperative and secure it against any unintended operation.

- Do not operate the instrument in the presence of flammable gasses or fumes. Operation of any electrical instrument in such an environment constitutes a definite safety hazard.

- Do not install substitute parts or perform any unauthorized modification to the instrument.

- Capacitors inside the instrument may retain a charge even if the instrument is disconnected from its source of supply.

- Use caution when exposing or handling the CRT. Handling or replacing the CRT shall be done only by qualified maintenance personnel.

#### Safety Symbols



Instruction manual symbol: the product is marked with this symbol when it is necessary for you to refer to the instruction manual in order to protect against damage to the product.



Hazardous voltage symbol.



Earth terminal symbol: Used to indicate a circuit common connected to grounded chassis.

#### WARNING

The Warning sign denotes a hazard. It calls attention to a procedure, practice, or the like, which, if not correctly performed or adhered to, could result in personal injury. Do not proceed beyond a Warning sign until the indicated conditions are fully understood and met.

#### CAUTION

The Caution sign denotes a hazard. It calls attention to an operating procedure, practice, or the like, which, if not correctly performed or adhered to, could result in damage to or destruction of part or all of the product. Do not proceed beyond a Caution symbol until the indicated conditions are fully understood or met.

### **Product Warranty**

This Hewlett-Packard product has a warranty against defects in material and workmanship for a period of one year from date of shipment. During the warranty period, Hewlett-Packard Company will, at its option, either repair or replace products that prove to be defective.

For warranty service or repair, this product must be returned to a service facility designated by Hewlett-Packard.

For products returned to Hewlett-Packard for warranty service, the Buyer shall prepay shipping charges to Hewlett-Packard and Hewlett-Packard shall pay shipping charges to return the product to the Buyer. However, the Buyer shall pay all shipping charges, duties, and taxes for products returned to Hewlett-Packard from another country.

Hewlett-Packard warrants that its software and firmware designated by Hewlett-Packard for use with an instrument will execute its programming instructions when properly installed on that instrument. Hewlett-Packard does not warrant that the operation of the instrument software, or firmware will be uninterrupted or error free.

### **Limitation of Warranty**

The foregoing warranty shall not apply to defects resulting from improper or inadequate maintenance by the Buyer, Buyer-supplied software or interfacing, unauthorized modification or misuse, operation outside of the environmental specifications for the product, or improper site preparation or maintenance.

**No other warranty is expressed or implied. Hewlett-Packard specifically disclaims the implied warranties of merchantability or fitness for a particular purpose.**

### **Exclusive Remedies**

The remedies provided herein are the buyer's sole and exclusive remedies. Hewlett-Packard shall not be liable for any direct, indirect, special, incidental, or consequential damages, whether based on contract, tort, or any other legal theory.

### **Assistance**

Product maintenance agreements and other customer assistance agreements are available for Hewlett-Packard products. For any assistance, contact your nearest Hewlett-Packard Sales Office.

### **Certification**

Hewlett-Packard Company certifies that this product met its published specifications at the time of shipment from the factory. Hewlett-Packard further certifies that its calibration measurements are traceable to the United States National Institute of Standards and Technology, to the extent allowed by the Institute's calibration facility, and to the calibration facilities of other International Standards Organization members.

### **About this edition**

This is the second edition of the *HP 16500B Setting Up the System Guide*.

Publication number  
16500-90923

Printed in U.S.A.

Edition dates are as follows:

First edition, May 1993

New editions are complete revisions of the manual. Update packages, which are issued between editions, contain additional and replacement pages to be merged into the manual by you. The dates on the title page change only when a new edition is published.

A software or firmware code may be printed before the date. This code indicates the version level of the software or firmware of this product at the time the manual or update was issued. Many product updates do not require manual changes; and, conversely, manual corrections may be done without accompanying product changes. Therefore, do not expect a one-to-one correspondence between product updates and manual updates.

The following list of pages gives the date of the current edition and of any changed pages to that edition.

All pages original edition